

LOVE THE ADVENTURE



Hanse 
BREAKING RULES . SETTING TRENDS



ADVENTURE | LOVE THE NATURE

Leben Sie das Abenteuer. Endloses Blauwassersegeln, fernab jeder Küste. Entdecken Sie neue Horizonte und herrliche Buchten. Mit der HANSE 508 ist alles möglich. Ihr progressives Design ist ein klares Statement. Ihre Performance eine der aufregendsten ihrer Klasse. Das Interieur liebevoll abgestimmt, fantastisch edel und einzigartig komfortabel. Durch eine Vielzahl intelligenter Individualisierungsmöglichkeiten wird die HANSE 508 höchsten persönlichen Ansprüchen an Flexibilität und Lebensqualität gerecht. Lassen Sie sich begeistern von eleganter Perfektion.

Live your own adventure. Here is a yacht crafted for endless blue-water sailing, far from any coast. Explore beyond the horizon and discover tranquil bays and limpid waters. Anything is possible with the HANSE 508. Her modern design is a clear statement. And her performance, one of the best in her class, will thrill sailors to the core. Make your mark below by selecting from our meticulously chosen finishes for an effortlessly stylish, comfortable interior. Through a range of smart customisation options, the HANSE 508 is flexible enough to fit into anyone's lifestyle. Let yourself be inspired by elegant perfection.



Auf hoher See zu Hause. Die markanten schnellen Rumpflinien und der beeindruckende Segelplan stammen aus der Feder von judel/vrolijk & co, den besten und erfahrensten Yacht-konstrukteuren der Welt. Ebenso ist die Kombination aus perfekt abgestimmtem Lateralplan und vorbalanciertem Ruderblatt ein Garant für Schnelligkeit und Sicherheit.

Feel at home on the high seas. The trademark fast hull line and the impressive sail plan come from the pen of judel/vrolijk & co, the world's best and most experienced yacht construction engineers. The combination of a perfectly harmonised lateral plan and a pre-balanced rudder blade is a further guarantee for high-speed performance and safety while you are sailing.

FAST

CRUISING



Feel the pleasure of

COMFORT SPEED

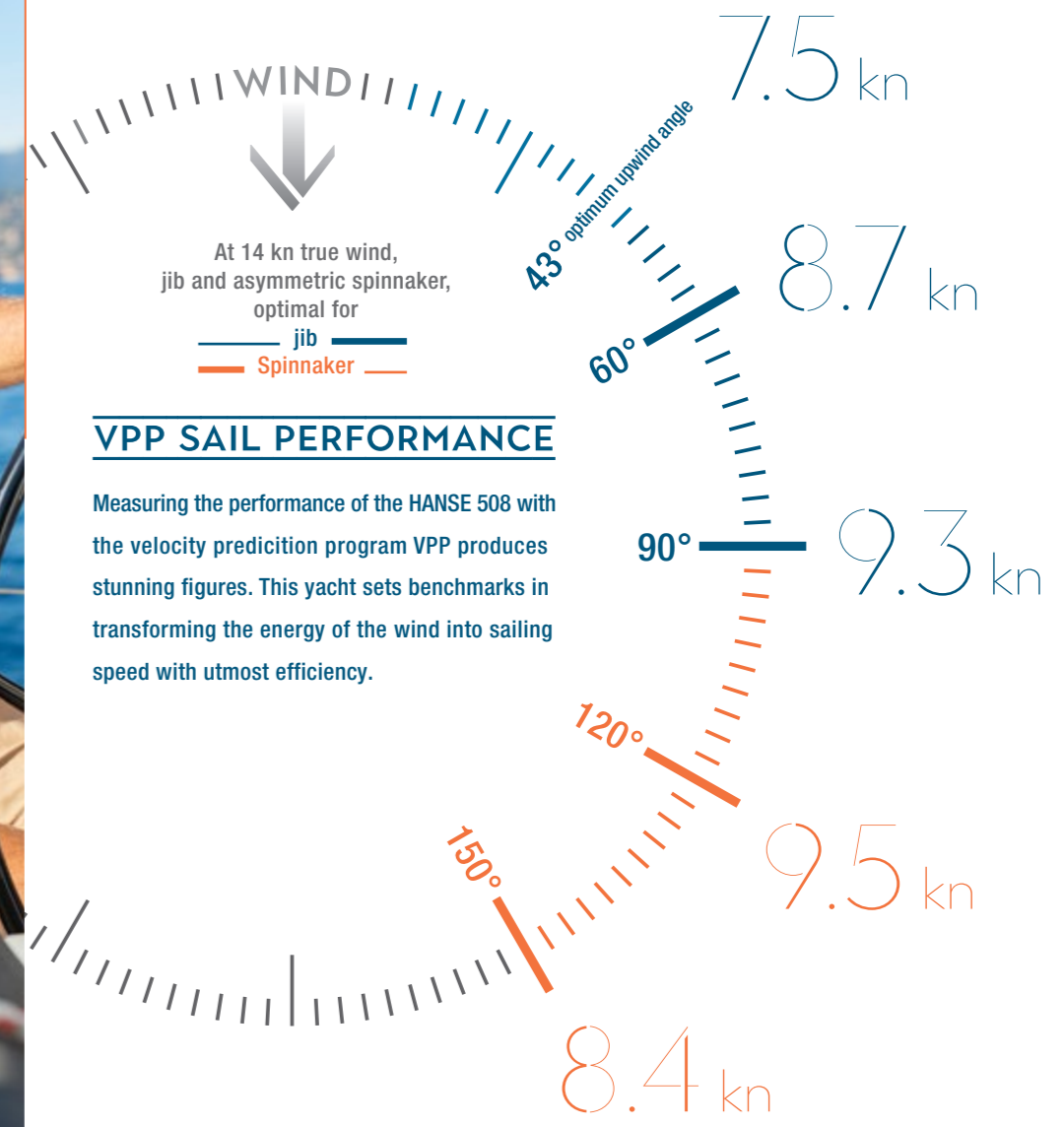

VPP SAIL PERFORMANCE

Measuring the performance of the HANSE 508 with the velocity prediction program VPP produces stunning figures. This yacht sets benchmarks in transforming the energy of the wind into sailing speed with utmost efficiency.

FAST CRUISING



RIG & SAIL OPTIMISATION

Ein hohes Rigg ist das Markenzeichen von HANSE. Die Yachtdesigner von judel/vrolijk & co passen den Segelplan mit hochentwickelten Berechnungsmodellen perfekt an jede HANSE an. Das garantiert beste Segeleigenschaften bei allen Bedingungen und macht eine HANSE zu der schnellsten Yacht in ihrer Klasse.

A high rig is the trademark of every HANSE. The yacht designers from judel/vrolijk & co perfectly form the sail plan for each HANSE with the use of highly sophisticated calculation models. This guarantees that you have the best sailing characteristics under all conditions, and it ensures your HANSE is the fastest yacht in its class.



15° heeling angle

CONSTANTLY LONG WATERLINE

Voraussetzungen für eine herausragende Performance sind das gerade Heck und der vertikale Steven. Dieses intelligente Design ermöglicht eine optimal lange Wasserlinie bei jedem Krängungswinkel – und damit eine überlegene Geschwindigkeit auf allen Kursen.

Outstanding performance comes from having a steep stern and a straight stem. This intelligent design provides an optimal, long waterline at any heeling angle – and superior speed for you on all courses.

FAST CRUISING



15^{LOA}.6 m
4^{BEAM}.8 m
2^{DRAFT}.4 m
14^{DISPLACEMENT}.7 t



HANSE SMART TRIM SYSTEM

Wir trimmen die Segel wie die Profis und setzen auf ein Achterstag, das sich stufenlos verstellen lässt. Damit können Mastbiegung und Profiltiefe der Segel jederzeit dem Wind angepasst werden.

We have trimmed the sail so you can sail like a pro and included a backstay, which can be adjusted seamlessly. This enables the mast and the profile of the sail to perfectly adapt to the wind at all times.



FAST CRUISING



Das HANSE Easy Sailing Concept ist legendär. Wir haben die integrierte Selbstwendefock konzipiert und alle Leinen zum Steuerstand geführt. So können Sie diese Yacht auch ganz alleine segeln. Das Reffen, Wenden und Segelsetzen erledigen Sie vom Steuerstand aus ganz ohne Anstrengungen. Das Deck ist kompromisslos frei von Leinen und Beschlägen, damit Sie unterwegs und im Hafen viel Platz zum Entspannen haben. So geht Segeln heute!

The HANSE Easy Sailing Concept is legendary. We invented the integrated self-tacking jib and brought all the lines to the helm. This means you can sail your yacht on your own. Reefing, tacking and setting sail can all be performed from the helm without any effort. The deck is free of lines and fittings, giving you uncompromising comfort and space while you are at sea or relaxing in the harbour.

EASY SAILING



HANSE ONE-ROPE REEF SYSTEM

Sie bestimmen die Größe der Segelfläche – und das ganz bequem vom Cockpit aus. Das HANSE Einleinen-Reffsystem ermöglicht einfaches und schnelles Handling.

You decide the size of the sail area – easily from the comfort of the cockpit. The HANSE One-Rope Reef System ensures that handling is quick and effortless for you.

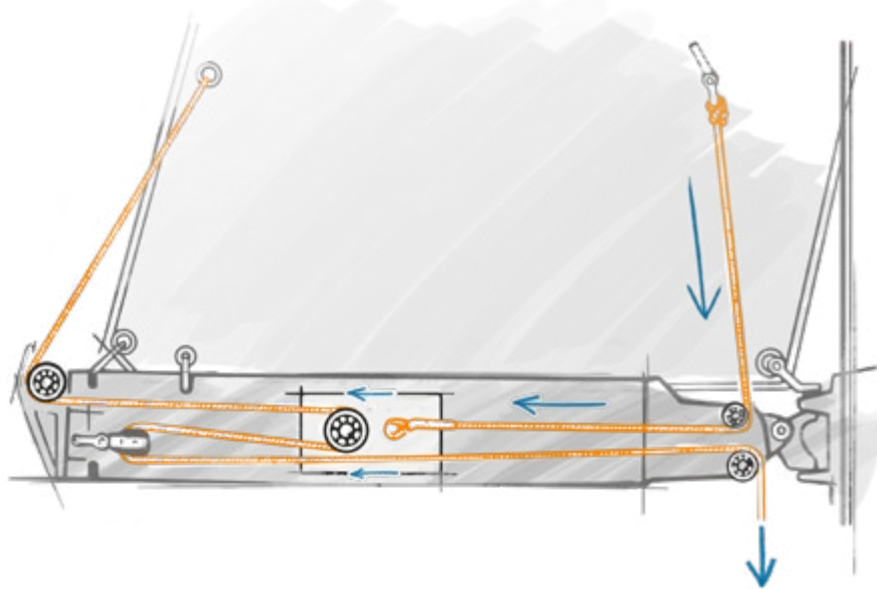

PURE DECK & COCKPIT

Clean und cool. Alle Flächen sind puristisch klar und aufgeräumt gestaltet. Die Fallen und Schoten verlaufen unsichtbar unter dem Deck.

Clean and cool. All spaces feature a minimalist design, with a pure and clear structure. We have even hidden the halyards and sheets elegantly below the deck.



HANSE SELF-TACKING JIB

Die Selbstwendefock ermöglicht einfache und schnelle Manöver. In der Wende oder Halse gleitet das Vorsegel über die integrierte Deckschiene von selbst auf die richtige Seite.

The self-tacking jib lets you easily and quickly manoeuvre the yacht. In the tack or the jibe, the headsail smoothly glides over the integrated deck rails automatically to the correct side.

EASY SAILING

HANSE RUDDER BALANCE

Beim Design der Ruderanlagen setzt HANSE kompromisslos auf Sicherheit bei gleichzeitiger Agilität. Deshalb haben wir ein vorbalanciertes Ruder entwickelt, dessen wirksame Oberfläche überdurchschnittlich groß ist. Damit lässt sich die Yacht in jeder Situation spielend leicht steuern.

When it comes to the design of the rudder system, HANSE gives you high agility without compromising safety. For this, we have developed a pre-balanced rudder whose efficient surface is larger than average. It makes steering the yacht in any situation child's play.

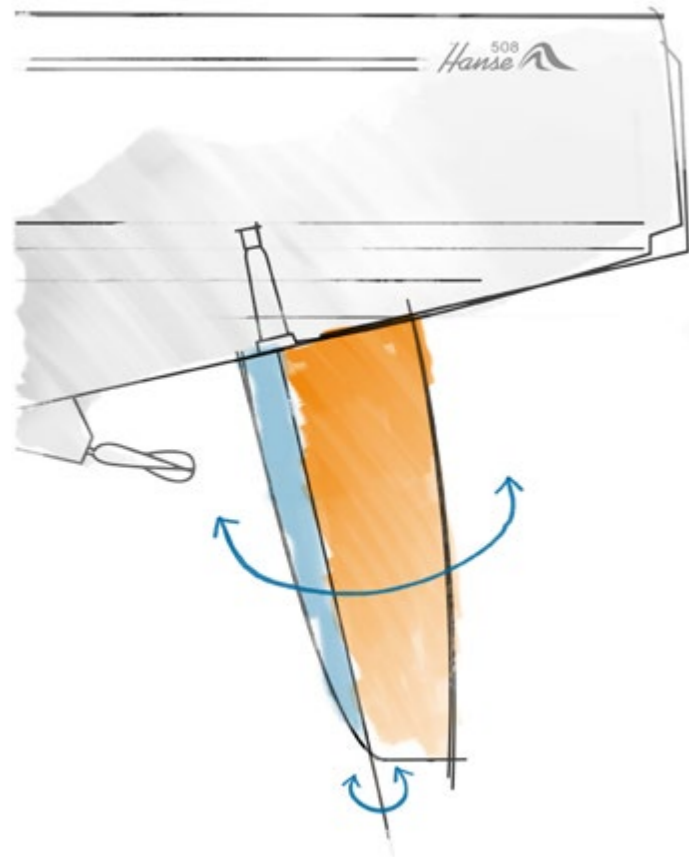

SECOND FORESTAY

Genoa oder Selbstwendefock? Das doppelte Vorstag von HANSE ermöglicht den komfortablen Wechsel vom Cockpit aus. Das richtige Segel ist immer angeschlagen.

Reacher or self-tacking jib? The second forestay of HANSE allows for a comfortable change from the cockpit. The right sail is always up and doesn't take any room for storage.

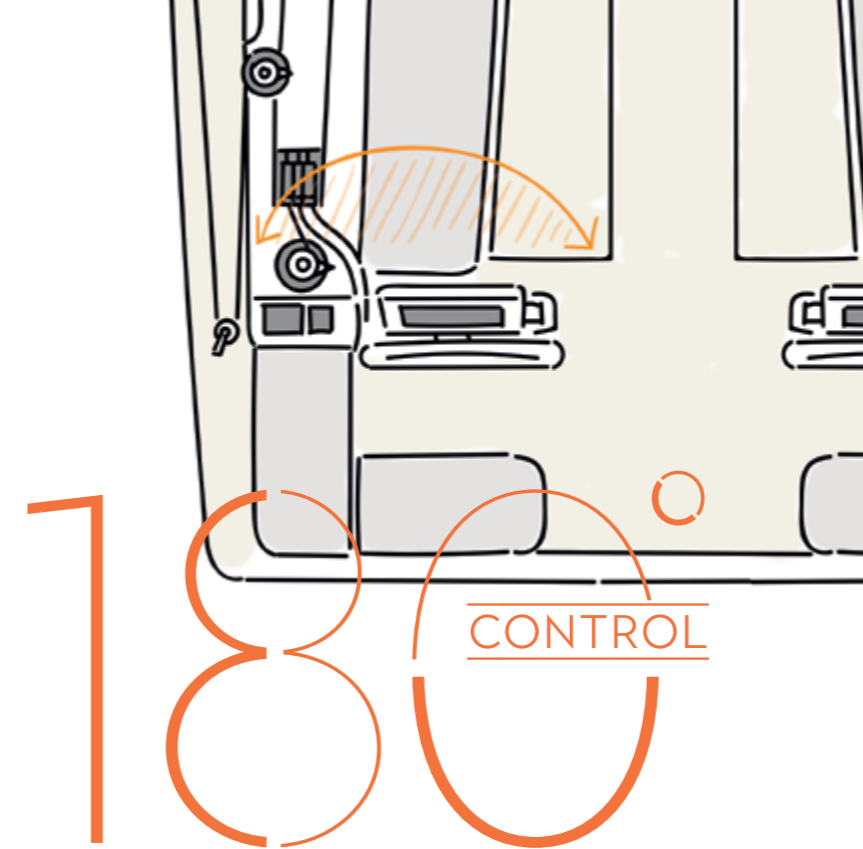

HANSE HELMSMAN CONTROL

Segeln per Knopfdruck? Bei HANSE keine Vision, sondern Wirklichkeit! Steuern Sie die gesamte Technik bequem vom Cockpit aus. Alle Schoten und Fallen führen zum Steuerstand, somit haben Sie die absolute Kontrolle in allen Segelmanövern.

Sailing at the touch of a button? With HANSE, your dream is now reality! Control the entire system from the cockpit. All the halyards and sheets also lead to the helmsman. This gives you absolute control in all sailing manoeuvres.





In allem einen Schritt voraus. Technische Innovationen und Detailqualität sind ebenso ein Teil von HANSE wie emotionale Formensprache und Wohlfühlatmosphäre. Dabei setzt jedes Detail ein klares Design-Statement. Das perfekte Zusammenspiel von fortschrittlicher Technologie und ihrer Umsetzung im Design ist unser Anspruch an die perfekte Yacht.

With HANSE, you have a progressive yacht that makes a statement. Technical innovations and quality in every detail are just as much part of the HANSE 508 as are an emotional design and comfortable atmosphere of well-being. Each detail is a subtle expression of superior design. The well-orchestrated ensemble of advanced technology and its integration is the highest art of yacht design at HANSE – and what drives us to create the perfect yacht.

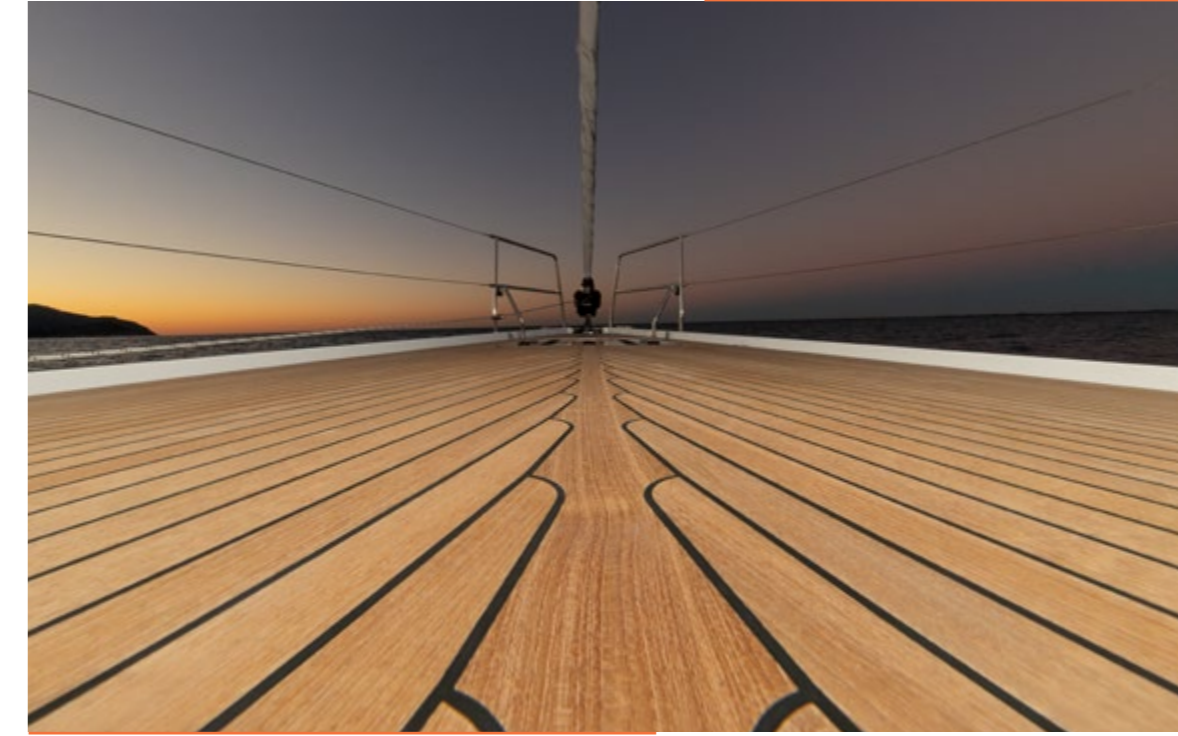

INNOVATIVE DESIGN



HIGH

EXTERIOR&INTERIOR

LIGHTS



1 Optional hydraulische Badeplattform mit Teak 2 Optionale Wetbar mit Waschbecken, BBQ und Kühlschrank
 3 Doppelter Steuerstand 4 Zwei absenkbare Cockpittische 5 Glas-Skylights seitlich vom Niedergang 6 Elf zu öffnende Decksluken 7 HANSE-Selbstwendefock 8 Drei Luken und zwei Rumpfenster zur Eigenerkabine
 9 Zweites Vorstag für Reacher und großen Gennaker 10 Geräumige Achterkabinen jeweils mit eigenem Bad für Kinder und Gäste 11 Schwenkbarer Fernseher 12 Kartentisch mit klappbarem Stuhl 13 Vollausgestattete Längs-Pantry an Backbord 14 Kolorierte Oberschränke in trendigem Pearl Grey oder Dove Grey 15 Komfortabler Salon mit Loungesofa für sechs bis acht Personen 16 Exklusive neue Hölzer und Dekore 17 Luxuriöse HANSE Silent Master Cabin mit Kingsize-Inselbett, viel Stauraum, großem Design-Bad und optionalem TV

1 Optional hydraulic bathing platform featuring teak wood 2 Optional wet bar with washbasin, barbecue and refrigerator
 3 Double helm 4 Two lowerable cockpit tables 5 Glass skylights on the sides of the companionway 6 Eleven openable deck hatches 7 HANSE self-tacking jib 8 Three hatches and two hull windows to the owner's cabin
 9 Second forestay for the reacher and large gennaker 10 Spacious cabins at the aft each with its own bathroom for children and guests 11 Swivel television 12 Chart table with foldable chair 13 Fully equipped, one-wall galley on the port side 14 Overhead compartments in the trendy colours Pearl Grey or Dove Grey 15 Comfortable saloon with lounge sofa for six to eight persons 16 Exclusive new woods and décors 17 Luxurious HANSE Silent Master Cabin with king-size island bed, lots of storage space, large designer bathroom and optional TV



SUN & FUN in perfection

Unter der Sonne zu Hause: **1** Mit absenkbaren Tischen und komfortablen Polstern verwandeln Sie das Cockpit in eine gemütliche Wellnessinsel. **2** Auch das Deck bietet viel Platz für Entspannung. **3 & 4** Wer Schatten und Abkühlung sucht, findet sie im luftigen Salon oder relaxt auf der Badeplattform.

Your new home under the sun: **1** Retractable tables and comfortable cushions transform the cockpit into a haven of wellbeing. **2** The deck also offers plenty of space for relaxation. **3 & 4** Catch a cooling breeze while you relax in the spacious cockpit or on the bathing platform.



INNOVATIVE DESIGN



Schönheit liegt im Detail: **1** Lange Linien und abgerundete Kanten verleihen der HANSE 508 eine moderne und edle Optik. **2** Mit optionaler Wetbar aus BBQ, Kühlfach und Waschbecken wird das Cockpit zum perfekten Lebensraum für gesellige Stunden. **3** Die Badeleiter ist praktisch integriert und bequem zu handhaben. **4** Optisch versteckte Ablagefächer lassen persönliche Utensilien elegant verschwinden.

Beauty lies in the details: **1** Long, slender lines and carefully rounded edges give the HANSE 508 a modern, elegant aesthetic. **2** With a barbecue, fridge and sink in the optional wetbar, the cockpit becomes the social hub of the boat. **3** The stylish bathing ladder is a joy to use and stowed away easily inside the bathing platform. **4** Subtly concealed lockers and drawers offer a supremely elegant way to stow your personal items.



INNOVATIVE DESIGN



INNOVATIVE INTERIOR DESIGN

Die Mischung aus Sonnenlicht und akzentuierten Beleuchtungseffekten. Das optische Zusammenspiel feinsten Stoffe und edler Möbelflächen. Die intelligente Raumnutzung durch bewegliche Einrichtungselemente. Eine beispiellose Individualisierbarkeit mit zehn Layout-Optionen unter Deck: Die HANSE 508 definiert, wie modernes Wohnen auf 50 Fuß heute aussieht.

The ideal combination of sunlight and lighting effects to accentuate the ambience. The optical interplay of fine fabrics and elegant furnishing surfaces. The intelligent use of space thanks to movable interior elements. The chance to customise like no other with ten layout options below deck. The HANSE 508 defines modern living over a length of 50 feet.



INNOVATIVE GALLEY

I



2



3



Komfort & Lebensqualität: **I** Die voll ausgestattete Längs-Pantry bietet höchsten Standard und exzellentes Design. **2** Mit zwei großen Kühlfächern verfügt sie über viel Platz für Lebensmittel. **3 & 4** Eine Spülmaschine und ein dreiflammiger Gasherd lassen Sie keine Annehmlichkeit vermissen.

Comfort and lifestyle: **I** The fully equipped longitudinal galley has been meticulously designed to the highest standards. **2** With two large refrigerators, you will never be short of fresh provisions. **3 & 4** A dishwasher and a three-burner gas stove give you the creature comforts of home.



MASTER CABIN

Perfekte Ruhezone: Die luxuriöse Silent Master Cabin fördert Ruhe und Entspannung durch maximale Schalldämmung. 1 Viel Stauraum und große Skylights sorgen für ein luftiges, liches Wohngefühl. 2 Ein en-suite Design-Bad garantiert absolute Privatsphäre.

Pure tranquility: Our luxurious Silent Master Cabin becomes a haven of peace and quiet thanks to advanced sound insulation. 1 Generous storage and large skylights combine to create a spacious and bright environment below. 2 The ensuite designer bathroom guarantees complete privacy.

Silent Master Cabin Concept



MASTER CABIN





GUEST CABIN

LUXURY

Hier lässt es sich wohnen: In den Gästekabine achtern setzt sich das helle und luftige Raumgefühl der HANSE 508 fort. Die Ausstattung ist sorgfältig gewählt und entspricht höchsten ästhetischen Ansprüchen an Farbsinn und Haptik. 1 Geräumige Schränke und Ablagen bieten viel Stauraum. 2 Auch das dazugehörige Bad verfügt über viel Platz. Stilvolle Armaturen, ein schmeichelndes Lichtkonzept und edle Materialien runden das Ambiente ab.

A place of your own: in the aft guest cabins, the airy feel of the HANSE 508 continues. Our designers choose the most exquisite fittings to create spaces that spoil the senses with fine textures and colours. 1 Large wardrobes, cupboards and shelves provide plenty of storage. 2 The en-suite bathroom offers impressive volumes. Stylish fittings, smart lighting and top quality materials complete the atmosphere.



Ein Ort zum Wohlfühlen: 1 Exklusive Hölzer und hochwertige Dekore schaffen ein außergewöhnlich inspirierendes Wohngefühl. Lounge-Sofa und eine variable Sitzbank garantieren herrlichen Komfort. Und das clevere Lichtsystem sorgt flexibel für die richtige Stimmung. 2 Wird der Navigationstisch nicht zum Navigieren benötigt, fungiert er als Arbeits- oder praktischer Beistelltisch. Der Sitz lässt sich je nach Bedarf platzsparend wegklappen.

Feel good: 1 Exclusive woods and high-quality finishing create a truly inspiring living space, while the lounge sofa and an adjustable bench offer great comfort. Our programmable lighting system always allows you to create the right mood. And the configuration is as flexible as you. 2 So when the chart table is not required for navigation, it can serve as a desk or handy side table. Or fold the seat away to save space.



Wohin Sie auch segeln – Ihre HANSE ist ein Unikat. Wählen Sie die Farbe des Rumpfes und auf welchen Polstern Sie Ihren Sundowner genießen. An Deck bestimmen Sie über die technische Ausstattung Ihrer HANSE-Yacht. Auch das Interieur trägt Ihre Handschrift. Genießen Sie die Freiheit auf See in einem coolen Loft oder umgeben von maritimer Eleganz. Wählen Sie einfach die für Sie perfekten Materialien und exklusiven Ausstattungen aus!

Wherever you sail – your HANSE is one of a kind. You choose the colour of the hull and which upholstery you would like to catch your eye. On deck, the decision of which technical equipment to include on your HANSE yacht is all yours. The interior also carries your signature. Enjoy the freedom at sea in a modern loft atmosphere or surrounded by maritime elegance. High-quality materials and exclusive fittings await you.



INDIVIDUAL

CUSTOMISATION

 508



Segeln Sie am liebsten zu zweit, mit der Familie oder im großen Freundeskreis? Die Raumaufteilung Ihrer HANSE 508 können wir individuell auf Ihre Wünsche zuschneiden. Sie haben die Wahl zwischen dem klassischen Standardlayout oder einem maßgeschneiderten Kabinen-Konzept für mehr oder weniger Gäste an Bord.

Do you prefer to sail with loved ones, your family or with a group of friends? The below-deck layout of your HANSE 508 can be adapted to your individual needs and desires. You can choose between the classic layout and a tailor-made cabin concept for many or just a few guests on board.

CABIN CONCEPT

INDIVIDUAL

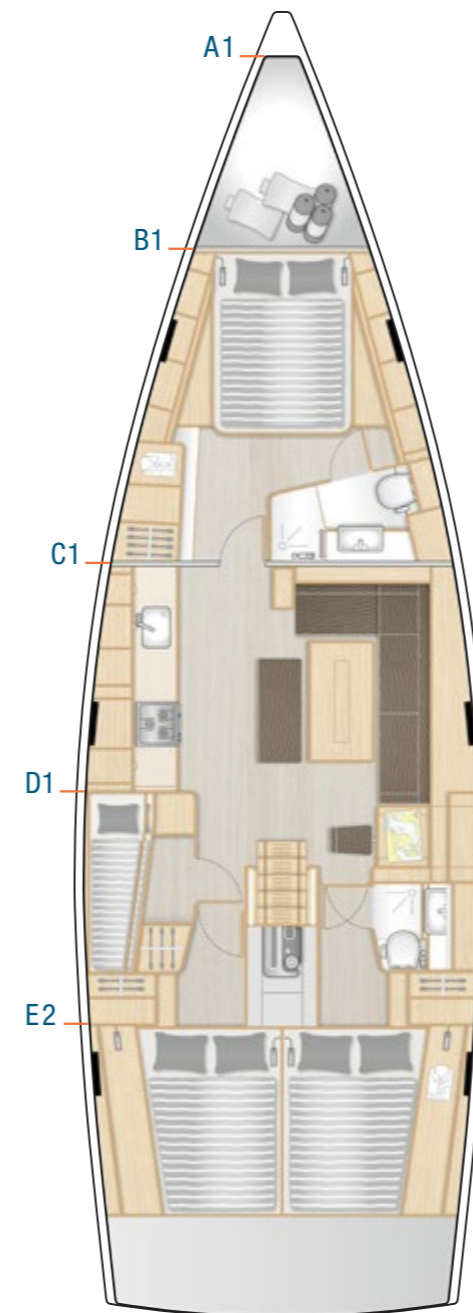

Standard

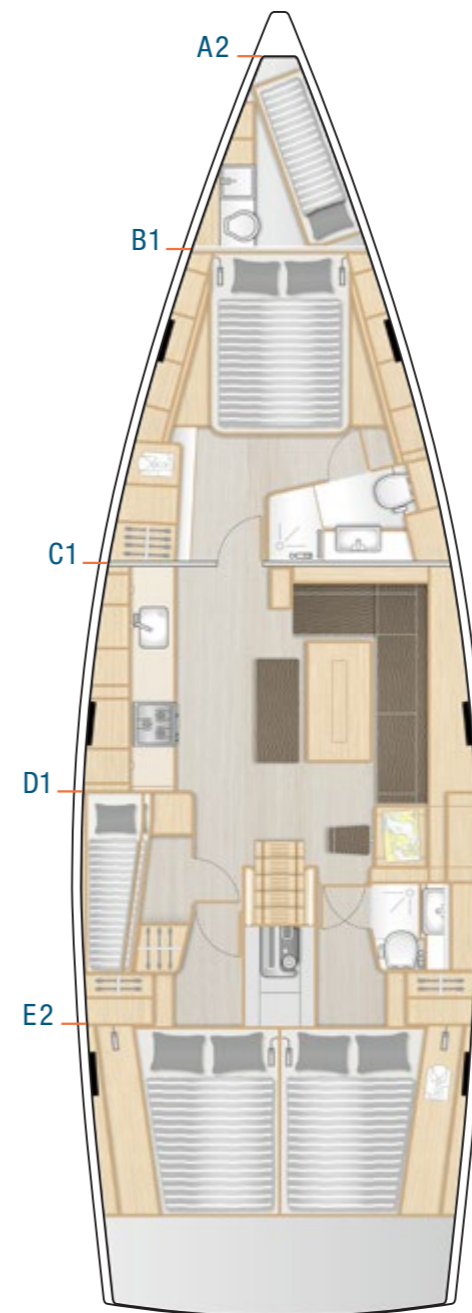

Option

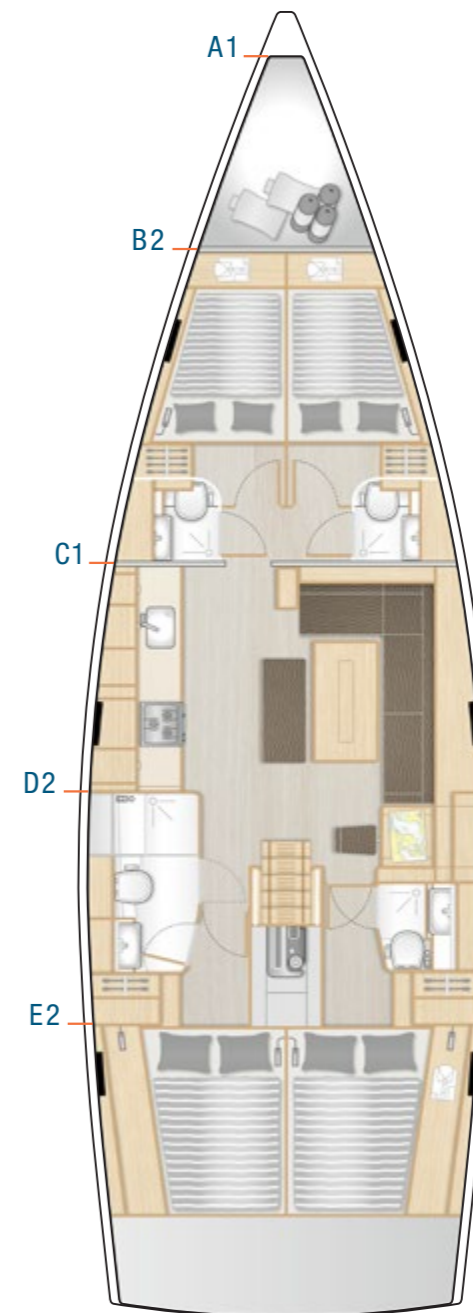

Option

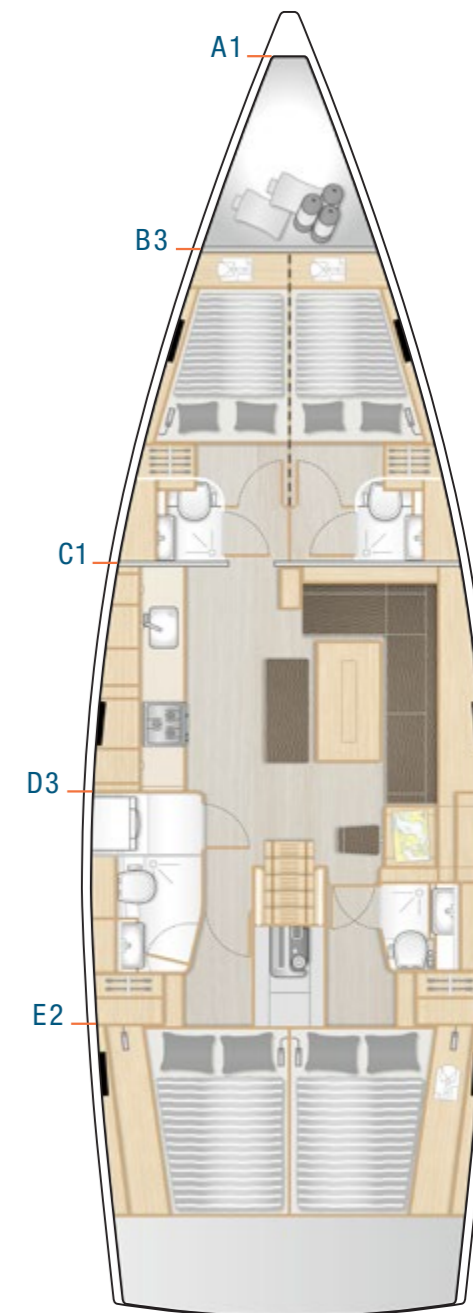

Option

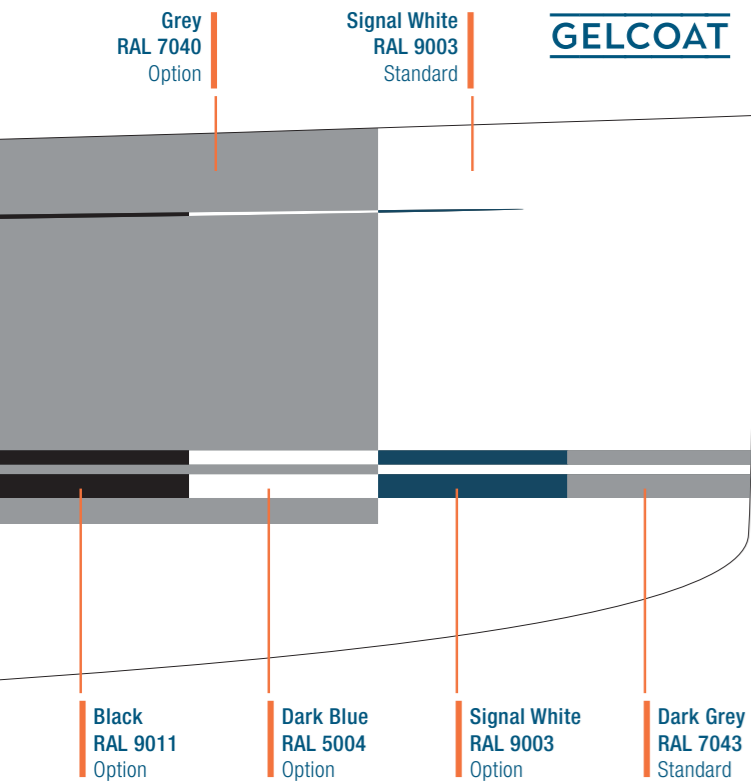

PAINTED

Bei HANSE können Sie aus einer Vielzahl Lackfarben auswählen. Ihr Händler hilft gerne bei der Auswahl.

At HANSE, you can choose from a variety of different paint colours. Your dealer will be happy to advise you.

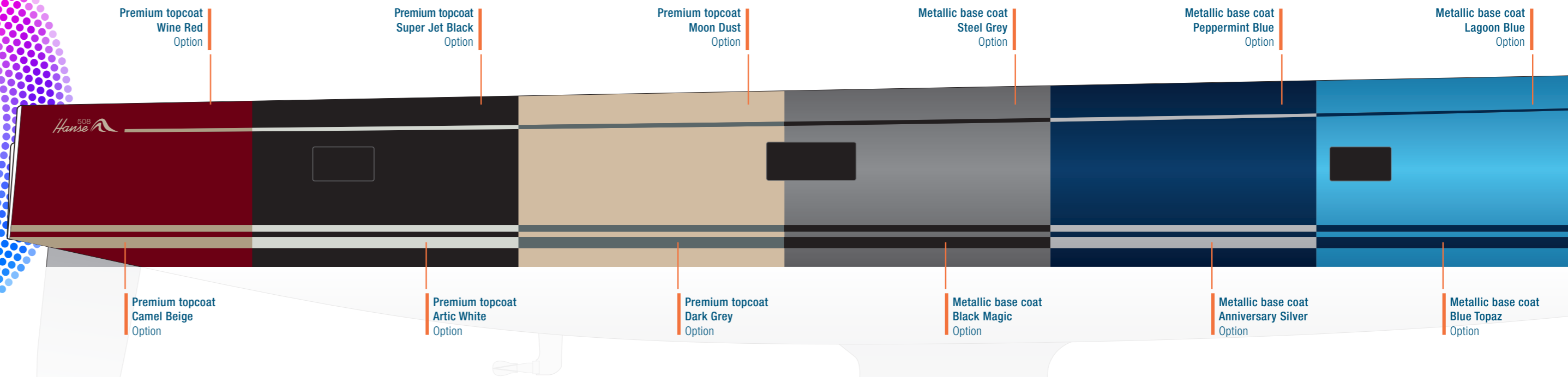

SYNTHETIC TEAK

Options: 1 Teak Black 2 Teak Grey 3 Teak White 4 Scrubbed Black 5 Scrubbed Grey 6 Scrubbed White 7 Weathered Black 8 Weathered White



TEAK Option

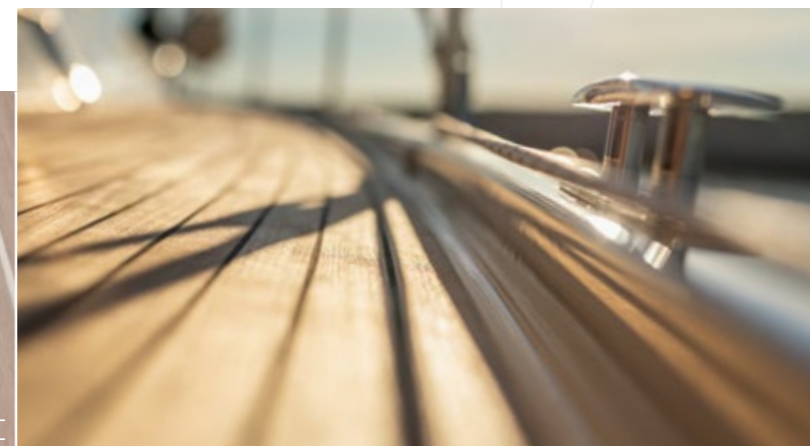

Rumpf- oder Wasserpassfarben, Gelcoat oder lackiert. Bei HANSE können Sie Farbe bekennen, aus einer Vielfalt an Möglichkeiten.

Hull and waterline colours, gelcoat or painted. At HANSE, you can select your favourite colour for your new yacht.

COLOURS
HULL & WATERLINE

STYLE

CREATE YOUR OWN LIFE

Eine individuelle Yacht für eine einzigartige Persönlichkeit. Wer eine HANSE segelt, will das Besondere. HANSE bietet Ihnen die Möglichkeit, dieses Besondere ganz persönlich zu gestalten. Ihrer Fantasie sind kaum Grenzen gesetzt. Unsere Experten helfen Ihnen gerne bei der Auswahl.

Your own individual yacht for your unique personality. Discerning connoisseurs sail HANSE, as we offer you the chance to express your style personally. There are no limits to how creative you can be. Our experts are happy to support you in choosing the perfect accents.



CUSHIONS FOR COCKPIT . SUNBED . HELMSMAN SEATS . WET BAR

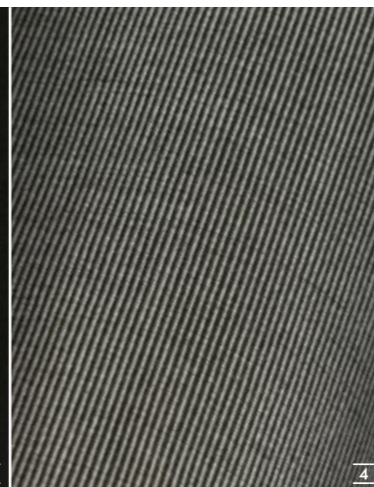
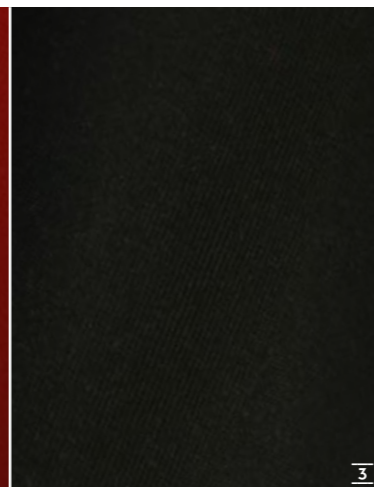

Options:

1 Dark Blue 2 Red 3 Black 4 Dark Grey 5 Light Grey 6 Cream

LAZY BAG . BIMINI . SPRAYHOOD . COVER . CANOPY CANVAS WINDSCREEN & COCKPIT

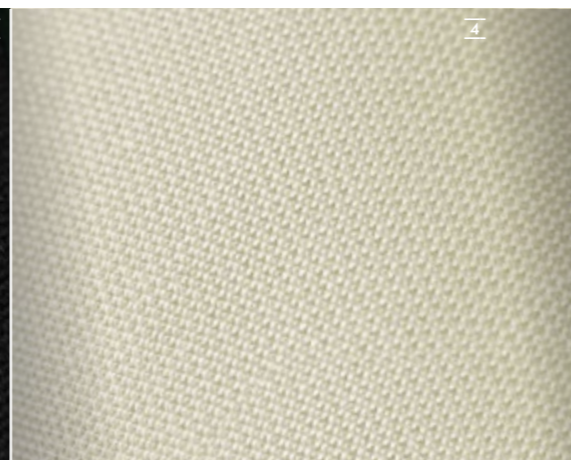
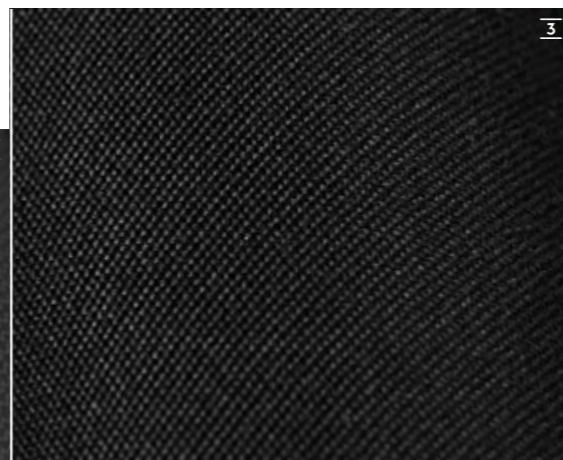
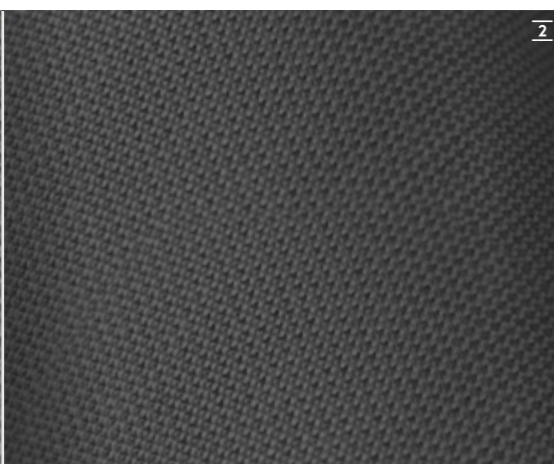

Options: 1 Light Grey 2 Dark Grey 3 Black 4 Cream

FURNITURE

Marine optimized real wood veneer from ALPI.

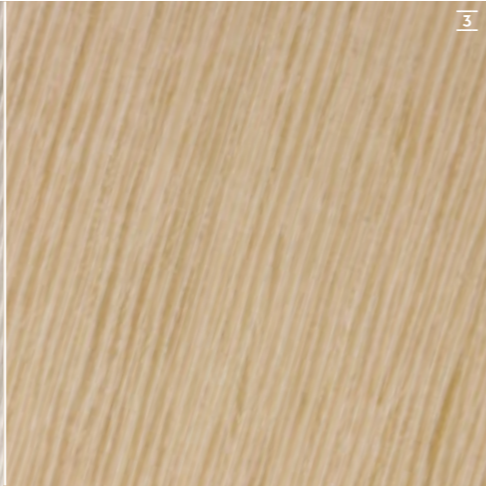

Standard: [1](#) Mahogany Style Satin Varnish · Options: [2](#) Canadian Chestnut Satin Varnish [3](#) French Oak



CUPBOARD FRONTS

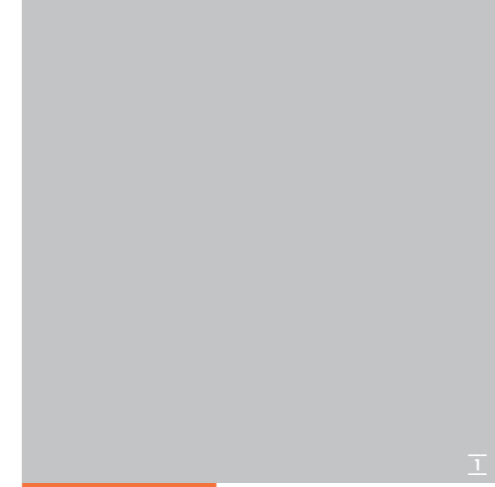

Options: [1](#) Pearl Grey [2](#) Dove Grey

FLOORBOARDS

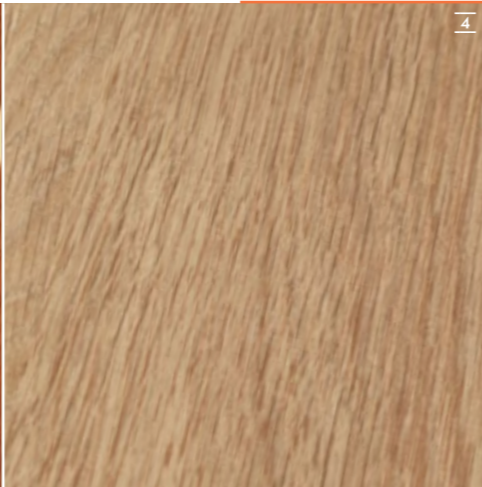
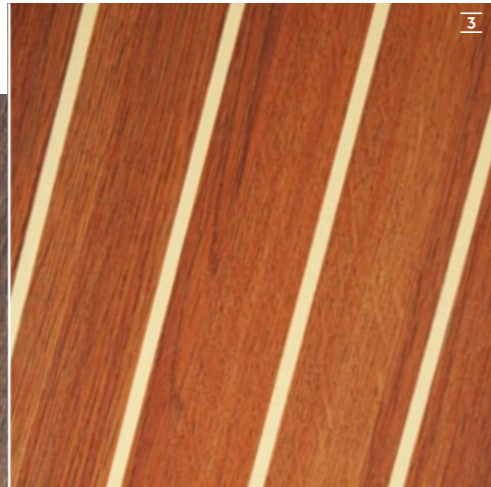
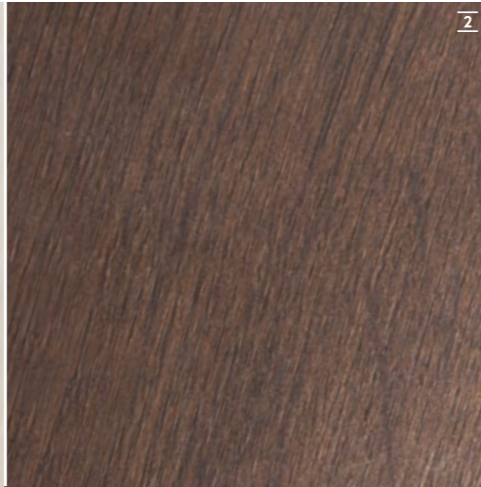
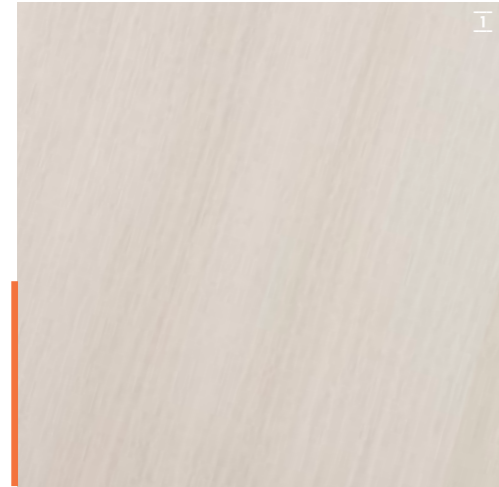

Standard: [1](#) Acacia · Options: [2](#) Noce Nero [3](#) Classic Stripes [4](#) Delight Oak

WORKTOP GALLEY

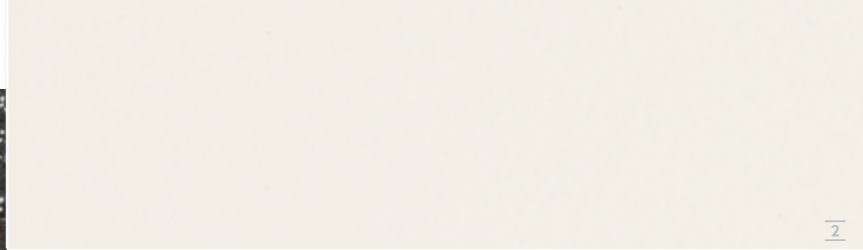
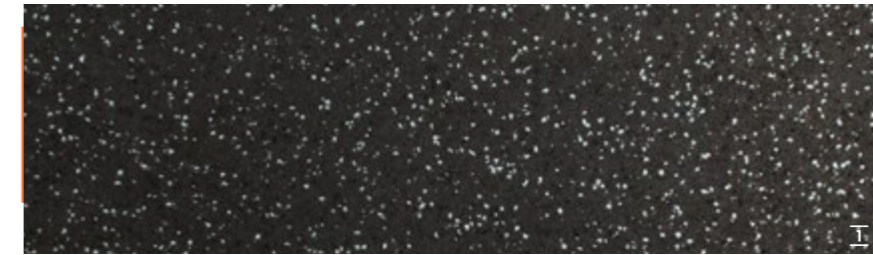

Standard: [1](#) Black Quartz · Option: [2](#) Seashell White

FABRICS INTERIOR



PORTOFINO LEATHER

Options: 1 Ivory 2 Basalt 3 Mud 4 Clay 5 Chocolate



MONTE CARLO

Standard: Cream



MONACO

Options: 1 Almond 2 Bronze 3 Rock Island
4 Black Truffle 5 Husky



SORRENTO

Options: 1 Taupe 2 Silver
3 Stone 4 Charcoral 5 Denim

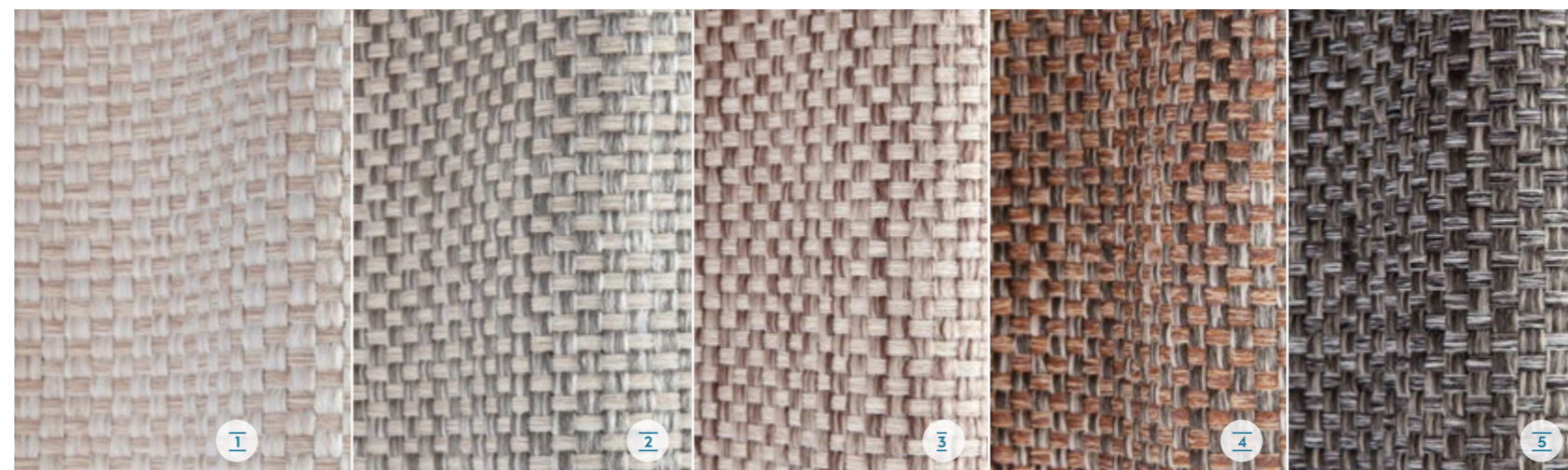

FLORENCE

Options: 1 Cliffside 2 Glacier
3 Oyster 4 Muscat 5 Graphite



1 Coast Gold 2 Red 3 Dark Blue 4 Ocean Blue 5 Black 6 Grey 7 Natural

And many more colours - it's your choice.



ACTIVE CRUISING SAILS

- QUANTUM SAILS IQ TECHNOLOGY®
- Höhere Formstabilität für bessere Segeleigenschaften
- Längere Lebensdauer für den ambitionierten Fahrtensegler
- Für HANSE Yachten exklusiv designed von Quantum
- Custom panel design

- QUANTUM SAILS IQ TECHNOLOGY®
- Increased stability for high performance
- High durability for ambitious cruising
- Exclusive design by Quantum for HANSE yachts
- Custom panel design

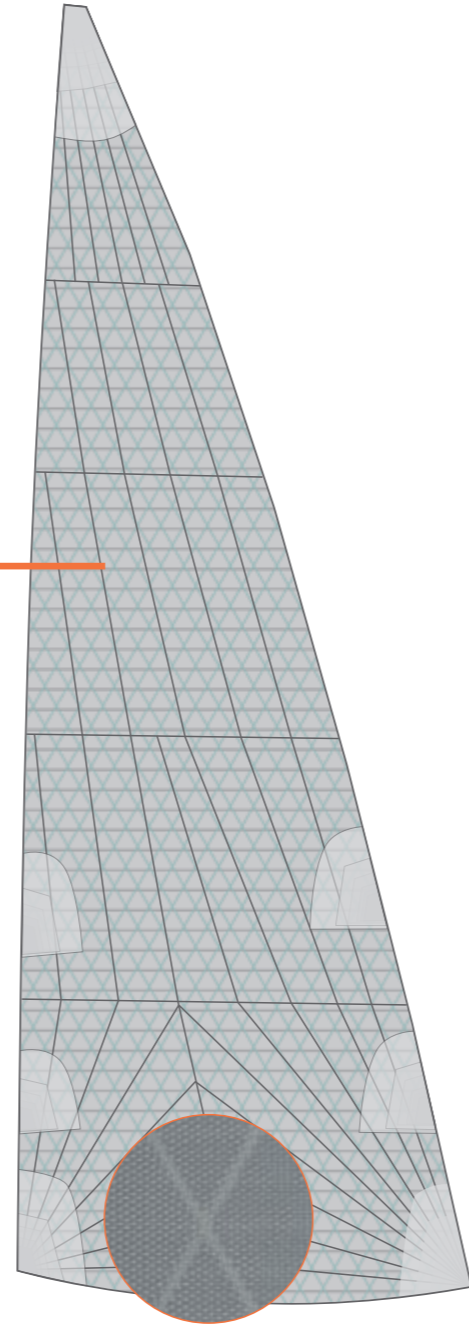
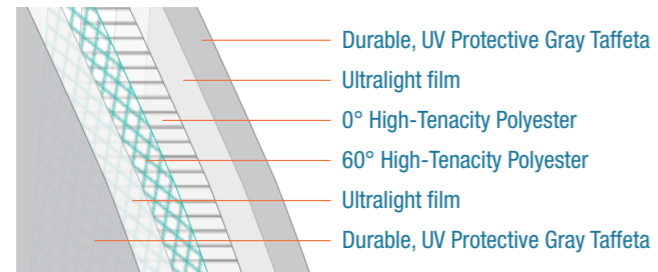

FUSION M CONSTRUCTION

Die Quantum IQ Technology® und die Fusion M™ Membran Konstruktion machten die Entwicklung des Quantum Segels TP6 Total Performance erst möglich. Durch enorme Leistung, Haltbarkeit und das einfache Handling der TP6 Segel schöpfen Sie das Potenzial Ihres Bootes voll aus. So erleben Sie außergewöhnliche Segelerlebnisse, selbst auf den anspruchsvollsten Kursen.

Quantum Sails TP6 Total Performance Cruising sails were engineered using Quantum's IQ Technology® design process paired with Fusion M™ membrane construction. TP6 sails give you the performance, durability, and usability you need to realize your boat's full potential and offer you the cruising experience you deserve from the outset through even the most demanding cruising adventures.

MAIN SAIL DETAILS



Head Corner Patch

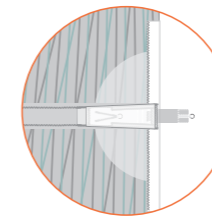

Batten Tensioning System

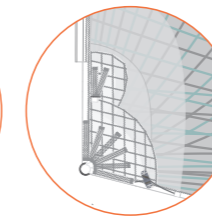

Tack Corner Patch

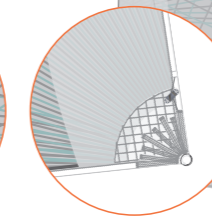

Clew Corner Patch



TOP PERFORMANCE SAILS

- QUANTUM SAILS FUSION M® CONSTRUCTION
- Höchste Formstabilität durch optimale Faseranordnung
- Maßgeschneiderte Faser- und Filamentmatrix-Strukturen
- Hohe mechanische Belastbarkeit durch Taffeta Lagen
- Extrem geringes Gewicht per m²

- QUANTUM SAILS FUSION M® CONSTRUCTION
- High form stability due to optimal membrane
- Custom fiber and filament matrix structures
- High mechanical strength thanks to Taffeta layers
- Extremely low weight per m²

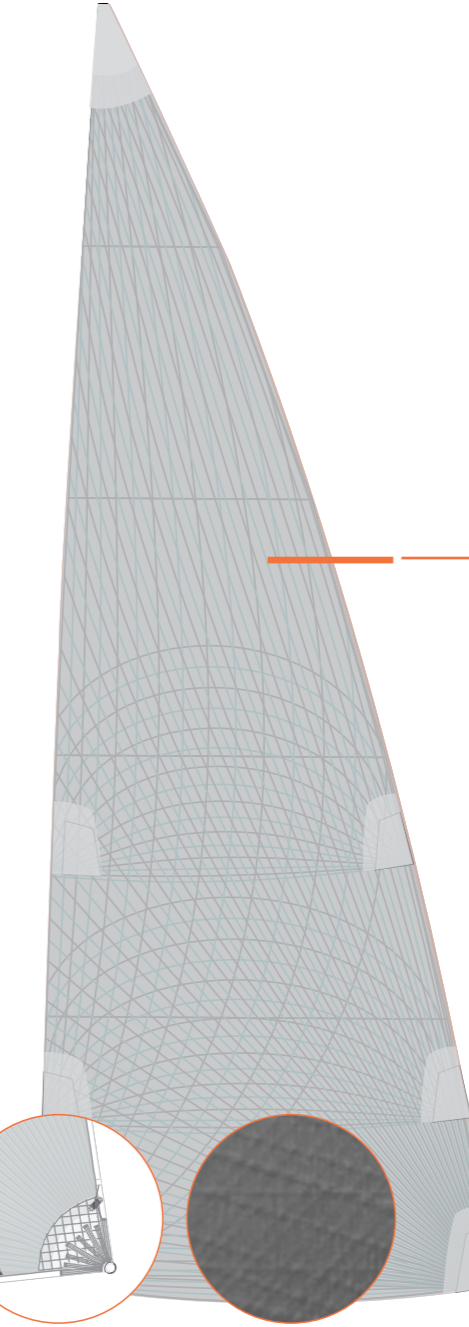
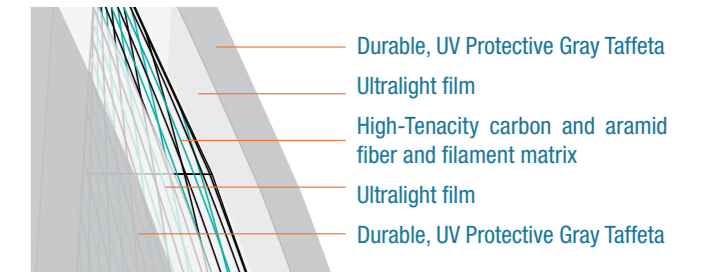

PERFORMANCE SAILS

GENNAKER

NAVIGATION PACKAGE B&G



B&G Zeus³S 9" chart plotter
starboard at helm station



B&G VHF V60
at chart table,
incl. wireless remote handset H60



B&G Autopilot
with Triton² control unit
and Precision 9 compass



2 B&G Triton² multifunction displays
in cockpit,
incl. transducer (wind/speed/depth/temperature)



2 instrument pods | VHF preparation with antenna and splitter for FM and AIS

UPGRADE H5000 INSTRUMENTS



2 B&G H5000 multifunction displays
incl. transducer (wind/depth/speed/temperature)
B&G Autopilot with H5000 control unit and
precision 9 compass
B&G CPU Hydra computer
GoFree WiFi adapter

UPGRADE SECOND CHART PLOTTER



B&G Zeus³S 9" chart plotter
port side at helm station



TV PACKAGE SALOON

TV preparation | Flat-screen LED TV
DVB-T2 antenna for TV

ENTERTAINMENT PACKAGE SALOON & COCKPIT



FUSION MS-AV755 Multimedia radio
with Bluetooth® and CD/DVD player,
for saloon und cockpit
FUSION wireless link
remote control via mobile devices



FUSION MS-NRX Remote Control
– Watertight control of all functions
in cockpit
– Control of iPod/iPhone music library
– Display of speed, depth, wind and
GPS via NMEA 2000 interface



4 high-end 2-way speakers
in saloon
2 high-end 2-way speakers
in cockpit
– Shock resistant, watertight

Fusion Subwoofer
with integrated amplifier in saloon
Wireless charging

X^{MORE}TRAS

508

Die Optionsvielfalt von HANSE gibt Ihnen mehr Freiheit – räumlich und gestalterisch. Hier finden Sie ausgesuchte Extras für Ihre HANSE 508.

The variety of individual options at HANSE gives you more freedom – spatially and artistically.



1 Badeplattform mit integrierter, bequem zu handhabender Badeleiter 2 Carbonite Steuerräder im Y-Spoke Design, in schwarz oder weiß 3 Hochwertige Polster für Cockpitlounge und Steuersitze für perfekten Komfort 4 Farblich abgestimmtes Bimini mit hochwertigem Edelstahlgestänge 5 Elektrische LEWMAR 55 EST EVO Fallwinschen 6 Wetbar mit BBQ, Kühlfach und Waschbecken 7 Edles Teakholz oder strukturechtes Synthetik-Teak für Deck und Cockpit in verschiedenen Farbtönen 8 Zweites Vorstag für Reacher und großen Gennaker

1 Bathing platform with integrated, easy-to-use bathing ladder 2 Black or white Carbonite steering wheels in Y-spoke design 3 High-quality cushions turn the cockpit into a cosy lounging area and make the helmsman's seats supremely comfortable 4 Coloured Bimini with high-quality stainless steel rods 5 Electric LEWMAR 55 EST EVO fall winches 6 Wetbar with BBQ, cool box and sink 7 Fine teak wood or genuine structured synthetic teak for deck and cockpit in different shades 8 Second forestay for Reacher and large gennaker

ORIGINAL ACCESSORIES



MADE IN
GERMANY
SINCE 1990

Breaking rules, setting trends – für uns ist das mehr als ein kluger Satz. Es ist eine Haltung, die wir mit jedem neuen Boot Wirklichkeit werden lassen. Eine Haltung, die Sie auf jeder Seemeile fühlen, erleben und genießen werden – und über die Sie auf den nächsten Seiten mehr erfahren.

Breaking rules, setting trends. To us, this is more than just a catchphrase. It is a commitment we make a reality with each finished yacht. A commitment you can feel, experience and enjoy sea mile by sea mile. Discover more about this on the following pages.



BREAKING RULES SETTING TRENDS

“ A blend of striking design, innovative features and very keen pricing has made this yard a real success story. ”

Sailing Today Magazine

Bis heute gewannen HANSE Yachten insgesamt mehr als 62 internationale Auszeichnungen.

To date, yachts made by HANSE have won more than 62 international awards.



OVER 60 ft

Jede fertiggestellte HANSE Yacht setzt Maßstäbe in technologischer Innovation, einfachem Handling und höchster Individualität. Das gilt bis in die höchste Bootsbau-Klasse

“ The HANSE 675 is a dream boat. Putting up the sails becomes a joyful experience: You can easily catch the wind and adjust to the wind strength. Mooring and anchoring



Bei berühmten Regatten feiern HANSE Yachten immer wieder große Erfolge, z.B. auf der Atlantic Rally for Cruisers, der Copa del Ray oder der Nordseewoche.

Time and time again, HANSE yachts achieve great successes in legendary regattas such as the Atlantic Rally for Cruisers, the Copa del Ray or the Nordseewoche.

“ Only boats with outstanding performance characteristics deserve the name HANSE. ”
Dr Jens Gerhardt | CEO HANSE

über 60 Fuss. | Each manufactured HANSE yacht sets a new benchmark in technical innovation, easy handling and extreme individuality. This also holds for the largest class in sailboat building over 60 feet.

are also one button push away. ” Philippe Fornier | HANSE 675 owner

HANSE entwirft seine Yachten in Zusammenarbeit mit den Weltklasse-Designern judel/vrolijk & co. Die erste gemeinsame Entwicklung wurde sofort zum Klassiker: die HANSE 371.

HANSE create their yachts in cooperation with world-renowned boat designers judel/vrolijk & co. Our first joint development became an instant classic: the HANSE 371.



“ HANSE has a tireless passion for new ideas. It's a pleasure to work with them. And a challenge, too. ”
Rolf Vrolijk

CONTINENTS

In allen Erdteilen schwören Segelbegeisterte auf HANSE. Das Händlernetz der weltweit zweitgrößten Segelyachtwerft liefert in 70 Länder.

All over the world, sailing enthusiasts favour HANSE yachts. The international dealer network of the world's second-largest sailing yacht manufacturer delivers to 70 countries.

“ At world's end, HANSE yachts are as highly coveted as in Germany. ”
Anthony Bishop | Dealer, Australia



HANSE steht für Innovationen, die einfach überraschen – und auf die man nie wieder verzichten will. Unser neuestes Beispiel: der E-MOTION RUDDER DRIVE der HANSE 315.

HANSE is best known for inventions that are surprising and indispensable at the same time. The latest example is the E-MOTION RUDDER DRIVE of the HANSE 315.

“Yachts by HANSE are the real 21st century boats. They shape the present and show the way into the future.”

Raoul Bajorat | Head of Development HANSE



“You won't find any production yacht more customisable than a HANSE.”

Maxim Neumann | Sales Director HANSE

Unsere Vielfalt an Polsterstoffen, Möbelhölzern oder Teppichen ergibt für den Eigner tausende Einrichtungsvarianten. Eine so große Auswahl ist einzigartig im Markt.

Thanks to the wide range of upholstery, furniture wood and carpets, we offer thousands of individual furnishing arrangements. A wide choice like this is unique in the market.

89



Bei HANSE arbeiten 890 segelbegeisterte Profis Hand in Hand. Unterstützt von modernsten Fertigungsprozessen. Getrieben von absoluter Hingabe zum Beruf.

At HANSE, 890 dedicated sailing enthusiasts work together hand in hand. Supported by cutting-edge production processes. Driven by total commitment to their profession.

“We and our customers are kindred souls: There is nothing we enjoy more than a flawlessly engineered sailing yacht.”

Pascal Kuhn | Product Marketing HANSE

Anfang der Neunziger revolutionierte die erste, je gebaute HANSE Yacht den Bootsmarkt: Sie wurde als erstes Serienboot mit integrierter Selbstwendefock ausgestattet.

In the early 1990s, the very first HANSE started a revolution in boat building. It featured the first integrated self-tracking jib ever produced in series.

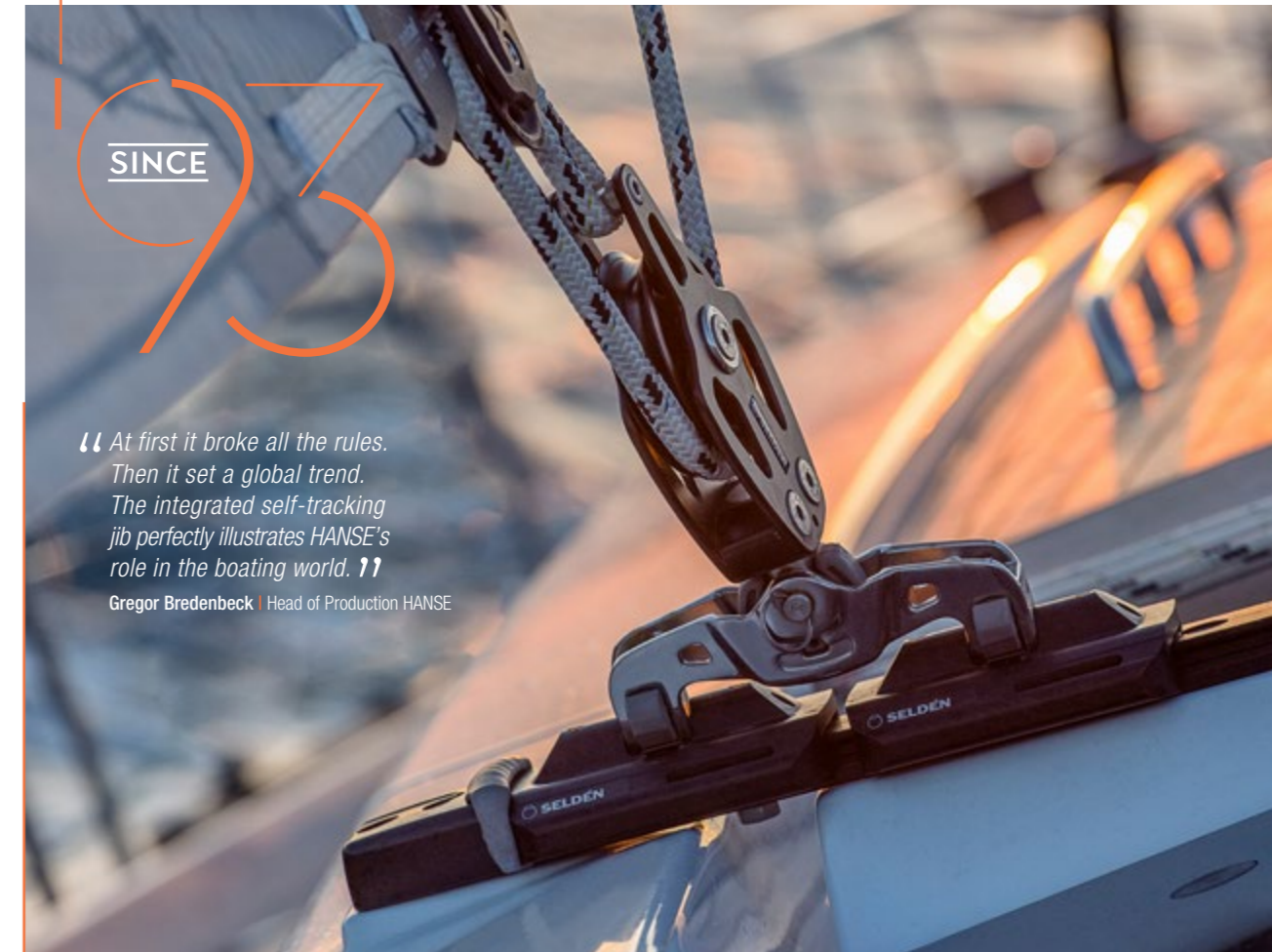

“At first it broke all the rules. Then it set a global trend. The integrated self-tracking jib perfectly illustrates HANSE's role in the boating world.”

Gregor Bredenbeck | Head of Production HANSE



Beeindruckend in jedem Detail, überwältigend als Gesamtwerk: HANSE-Yachten sind weit mehr als die perfekt abgestimmte Verbindung von Design und modernsten Technologien. Sie repräsentieren die Erfahrung und das Wissen der HANSE Ingenieure. Ihre Leidenschaft zum Yachtsport lassen sie in unvergleichlicher Präzision und Akribie in jeder HANSE Wirklichkeit werden.

Impressive in every detail, HANSE yachts are masterpieces made to take your breath away. They are far more than a perfectly harmonised ensemble of design and the most modern technologies. They reflect the experience and know-how of HANSE engineers. Their passion for yachting can be felt in the unmistakable precision and meticulous detailing found in every HANSE.



HANSE
ENGINEERING



MY HANSE SAFETY CLOUD

Alles unter Kontrolle. Mit der MyHanse Safety Cloud haben Sie vollen Zugriff auf alle wichtigen Daten Ihrer HANSE. Jederzeit und von jedem Ort aus. Intelligente Anwendungen wie BoatMonitoring, eLogBook und eServiceBook ermöglichen es Ihnen, Ihre Yacht unkompliziert und bequem zu überwachen, automatisch Logbuch zu führen und sämtliche Wartungstermine stets im Blick zu behalten.

Everything under control. With the MyHanse Safety Cloud you gain full access to all important data of your HANSE. At any time and any place. Intelligent applications as BoatMonitoring, eLogBook and eServiceBook allow you to supervise your yacht easily and comfortably, to keep the logbook automatically up to date and to keep an eye on all maintenance dates.

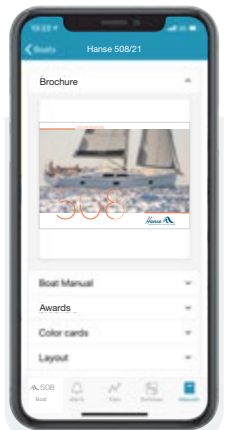

MANUALS

Alle Handbücher und Anleitungen in einer App.
All manuals and instructions within one app.

- FRIDGE**
Turn on/off remotely
- HATCH/DOOR SENSOR**
Monitor unauthorized access
- LIGHTS**
Turn on/off
- SHORE POWER**
Monitor connection
- ENGINE**
Monitor activity
- MOTION SENSOR**
Collision and grounding detection
- FUEL TANK**
Monitor level
- GPS, WIND AND SPEED DATA**
- BATTERY BANK**
Monitor level
- WATER TANK**
Monitor level
- ANCHOR WINCH**
Monitor activity
- BOW THRUSTER**
Monitor activity
- BILGE PUMP**
Monitor activity

*Steuerung und Sensoren sind abhängig von der Konfiguration Ihrer HANSE. / Controlling and sensors depend on the configuration of your HANSE.

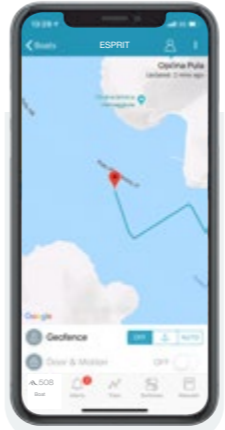

POSITION

Verfolgen Sie Ihre Position in Echtzeit.
Track your position in real-time.



SENSORS

Überwachen Sie Ladestände und Geräte.
Monitor your charge levels and devices.

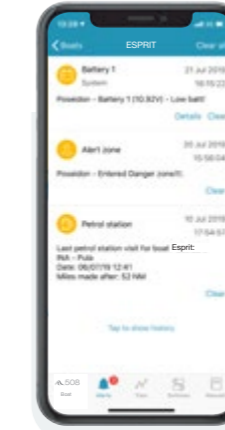

ALARMS

Push-Nachrichten bei aktuellen Ereignissen.
Push notifications on current events.

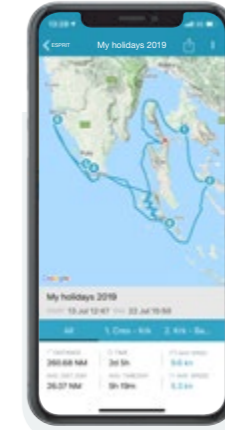

TRIP LOG

Teilen Sie Ihre geloggten Törns mit Freunden.
Share your cruises and track data with friends.

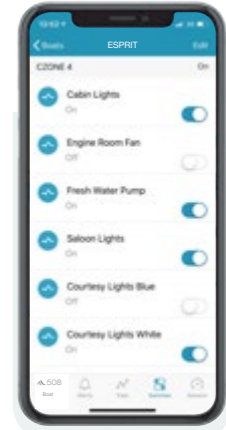

CONTROL

Bedienung elektronischer Geräte per Fernsteuerung.
Operate your electronic devices by remote control.



LIFE REPORT

Direkter Händler Kontakt für schnelle Hilfe.
Direct contact to your dealer for quick help.



BULWARK

Für das gute Gefühl auf See: Die extrahohe Fußreling von HANSE. Sie vereint die dynamischen Rumpflinien elegant mit dem hohen Seezaun und sorgt so für ein Maximum an Sicherheit.

For your good feeling at sea: the extra-high bulwark from HANSE. It elegantly combines the dynamic hull lines with the high railing and thus ensures a maximum of safety.

KEEL HULL CONNECTION

Safety first. Die Kielplatten liegen sicher in einem ultrafesten Bett aus Epoxidharzkleber. Dadurch ist der Kiel direkt in der mächtigen Bodenstruktur verankert. Die Kiel-Bolzen inklusive Scheiben und Muttern sind aus Edelstahl gefertigt.

Safety first. The keel plates lie securely in an ultra-strong bed made of epoxy resin. This means that the keel is directly anchored in the powerful floor structure. The keel bolts, including discs and nuts, are made of stainless steel.



- Stainless steel bolts
- Deck
- Best formulated performance glue
- Hull
- Threaded aluminum plate

HULL-DECK CONNECTION

In Zusammenarbeit mit judel/vroljik & co hat HANSE eine spezielle Deck-Rumpf-Verbindung entwickelt, die deutlich über den allgemeinen Anforderungen liegt. Neben dem Einsatz von hochfestem Polyesterklebharz, werden Deck und Rumpf mithilfe von Bolzen in den Klampen zusätzlich verankert und ergeben eine steife, torsionsfreie Yacht mit sportlichem Charakter.

In collaboration with judel/vroljik & co, HANSE has developed a special hull-deck connection which goes well beyond all standard requirements. In addition to the use of highly robust polyester bonding resin, the deck and hull are anchored with the use of high-strength bolts in the cleats. This results in a stable, torsion-free yacht with a sporty character.

SANDWICH CONSTRUCTION

Die HANSE 508 wird im hochwertigen Sandwichverfahren gebaut. Der Rumpf besteht aus mehreren Schichten ausgewählter Materialien und ist bis ins Detail genau berechnet. Er ist dadurch besonders leicht und dank der äußeren Vinylester-Laminatschicht vollkommen resistent gegen Osmose.

The HANSE 508 is constructed using the high-quality sandwich process. The hull features several layers of select materials and is precisely calculated in every detail. It is particularly lightweight and, thanks to the exterior vinylester layer, completely resistant to osmosis.



- GRP laminate
- Balsa core
- GRP laminate
- Vinylester
- Gelcoat



508

SPECIFICATIONS



Beam 4.75 | 15'7"

LOA 15.55 m | 51'

LOA		15.55 m	51'
Hull length		14.93 m	49'
LWL		13.54 m	44'5"
Beam		4.75 m	15'7"
Draft			
L-keel medium		2.40 m	7'10"
L-keel shallow		1.98 m	6'6"
Displacement			
L-keel medium	approx.	14.70 t	32,408 lb
L-keel shallow	approx.	15.10 t	33,290 lb
Ballast			
L-keel medium	approx.	4.05 t	8,939 lb
L-keel shallow	approx.	4.43 t	9,766 lb
Engine Diesel			
standard	approx.	80 PS	80 HP
Fuel tank	approx.	280 l	74 gal
Fresh water	approx.	630 l	166 gal
CE Certificate	A -12 ocean		
Design	judel/vrolijk & co		
Interior	HanseYachts Design		

Mast length above WL	approx.	22.05 m	72'4"
Total sail area	approx.	118.00 m ²	1,270 sq ft
Main sail			
standard	approx.	66.50 m ²	716 sq ft
furling	approx.	61.00 m ²	657 sq ft
Self-tacking jib	approx.	51.50 m ²	554 sq ft
Gennaker	approx.	200.00 m ²	2,153 sq ft
Reacher	approx.	87.00 m ²	936 sq ft
Rig			
I		19.10 m	62'8"
J		6.13 m	20'1"
P		18.35 m	60'2"
E		6.15 m	20'2"

All measurements are approximate. Specification and material can be changed without notice. Errors excepted.



This brochure is not contractual. The yachts depicted partly comprise special equipment not included in the standard scope of supply. Illustrations may not correspond with current versions. Subject to alterations in design and equipment without notice and errors excepted. Photos/Illustrations: HanseYachts AG, Nico Krauss, Peter-Paul Reinmuth, Björn Willer, Jude/Vrolijk & co, Malwini Faber, Navico, B&G, Fusion, Elvstrom, Nico Martinez. Design: design-harkeisen.de & ulfson.de | Print: Druckhaus Pantzig

C18508/E/0920